













Baptist Medical Center

First Floor

First Floor

Legend



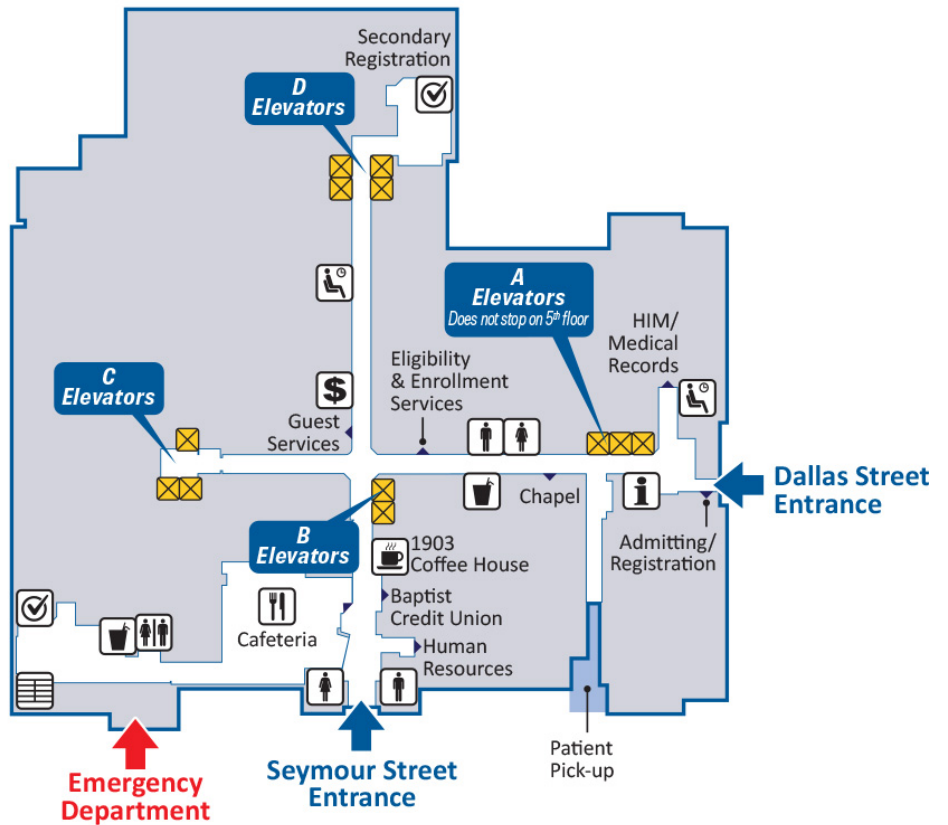

-  Elevator(s)
-  Stairs
-  Information Desk
-  Check-in/ Registration
-  Waiting Area
-  Restroom
-  Men's Restroom
-  Women's Restroom
-  Vending
-  Coffee Shop
-  Dining Area
-  ATM



Second Floor

Second Floor

Legend



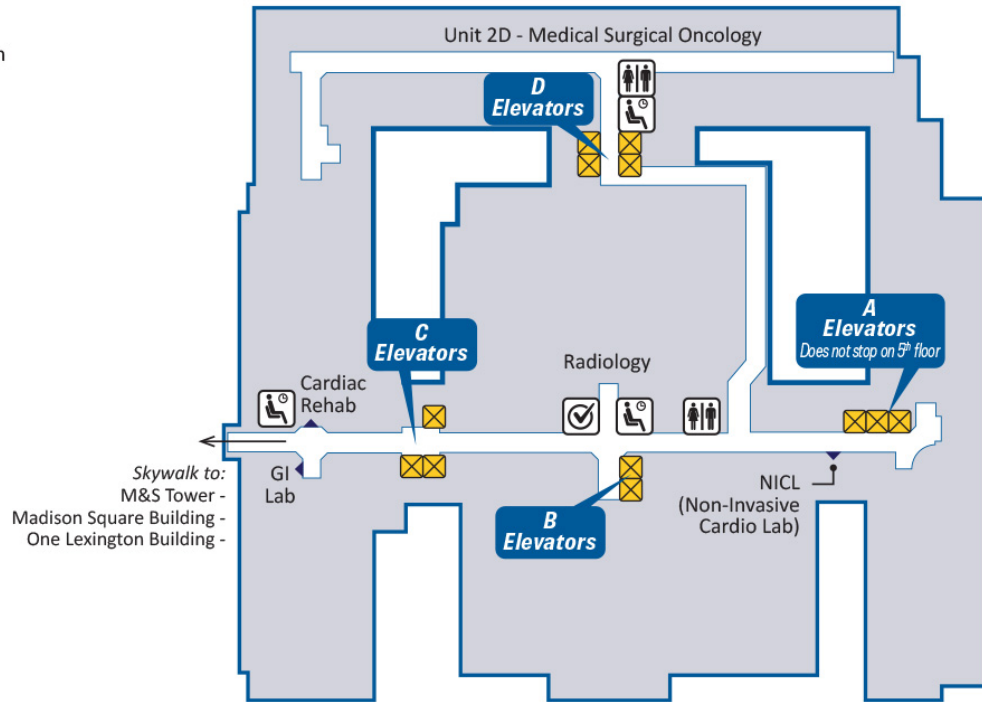

-  Elevator(s)
-  Check-in/ Registration
-  Waiting Area
-  Restroom



Third Floor

Third Floor

Legend

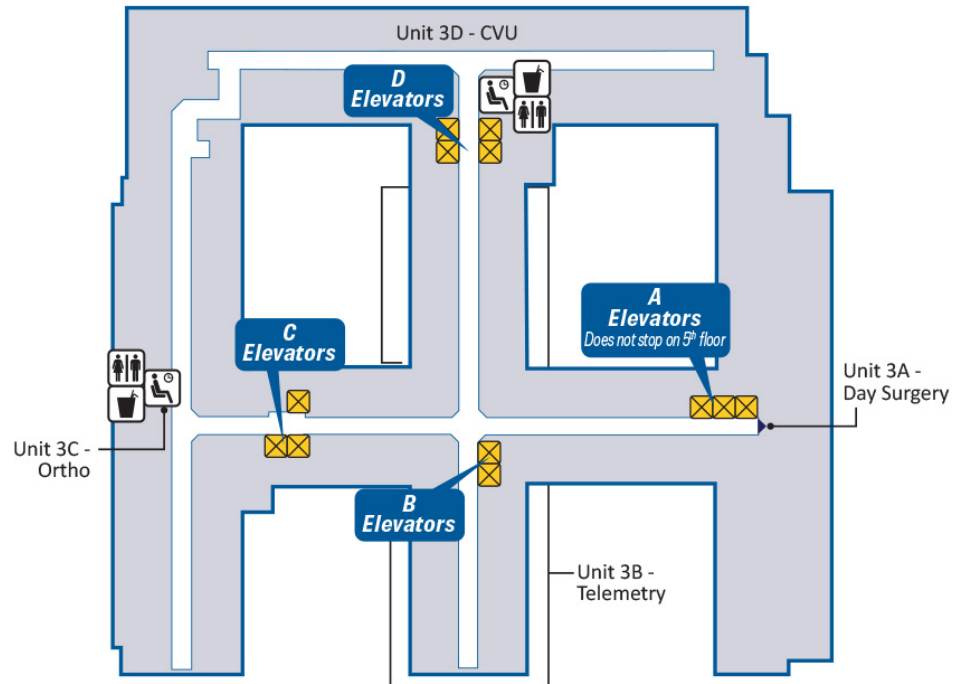

-  Elevator(s)
-  Waiting Area
-  Restroom
-  Vending



Fourth Floor

Fourth Floor

Legend

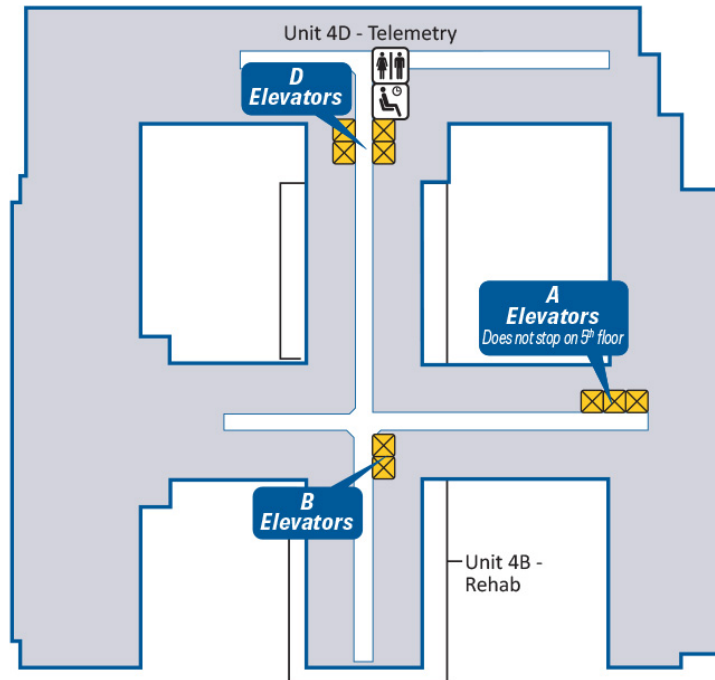

-  Elevator(s)
-  Waiting Area
-  Restroom



Fifth Floor

Fifth Floor

Legend



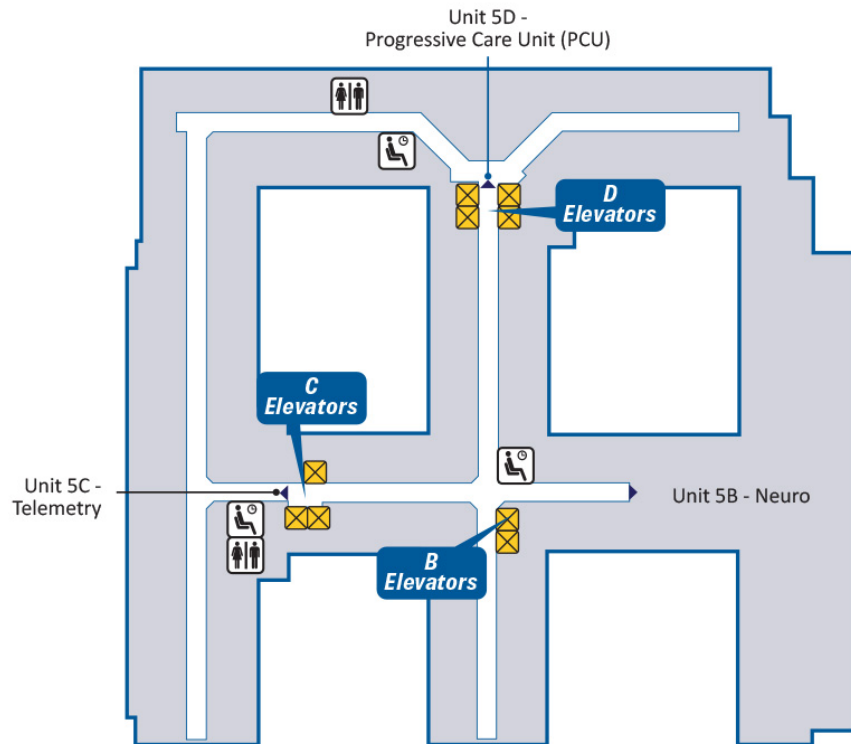

-  Elevator(s)
-  Waiting Area
-  Restroom



Sixth Floor

Sixth Floor

Legend



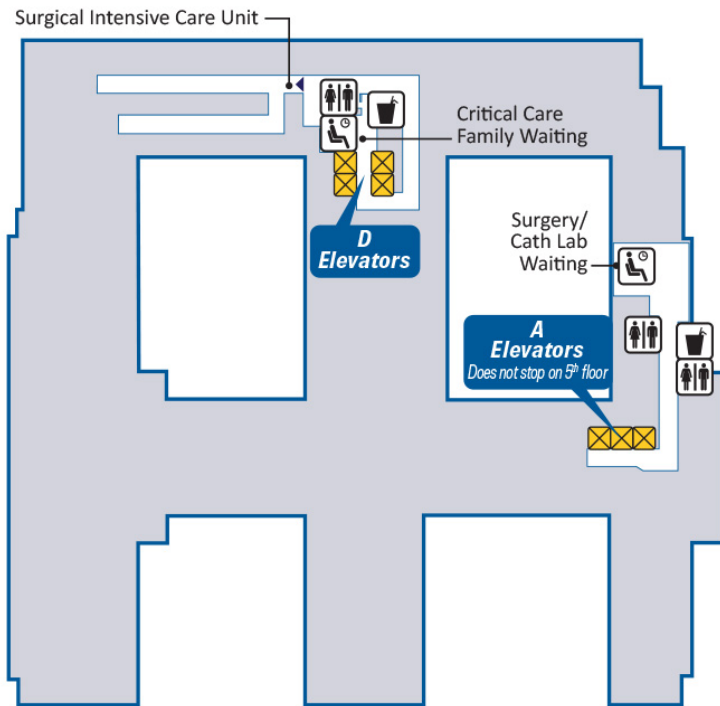

-  Elevator(s)
-  Waiting Area
-  Restroom
-  Vending



Seventh Floor

Seventh Floor

Legend



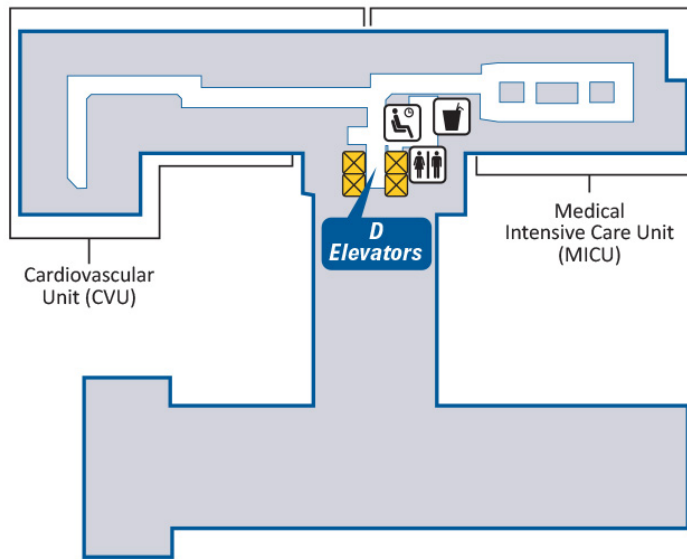

-  Elevator(s)
-  Waiting Area
-  Restroom
-  Vending



Eighth Floor

Eighth Floor

Legend

-  Elevator(s)
-  Waiting Area
-  Restroom
-  Vending

