

Baptist Medical Center

Primer piso

Primer piso

Leyenda

- Ascensor(es)
- Escaleras
- Información
- Admisión/ Registro de pacientes
- Area de espera
- Baños
- Baño de hombres
- Baño de mujeres
- Máquina expendedora
- Cafeterías
- Comedor
- Cajero automático

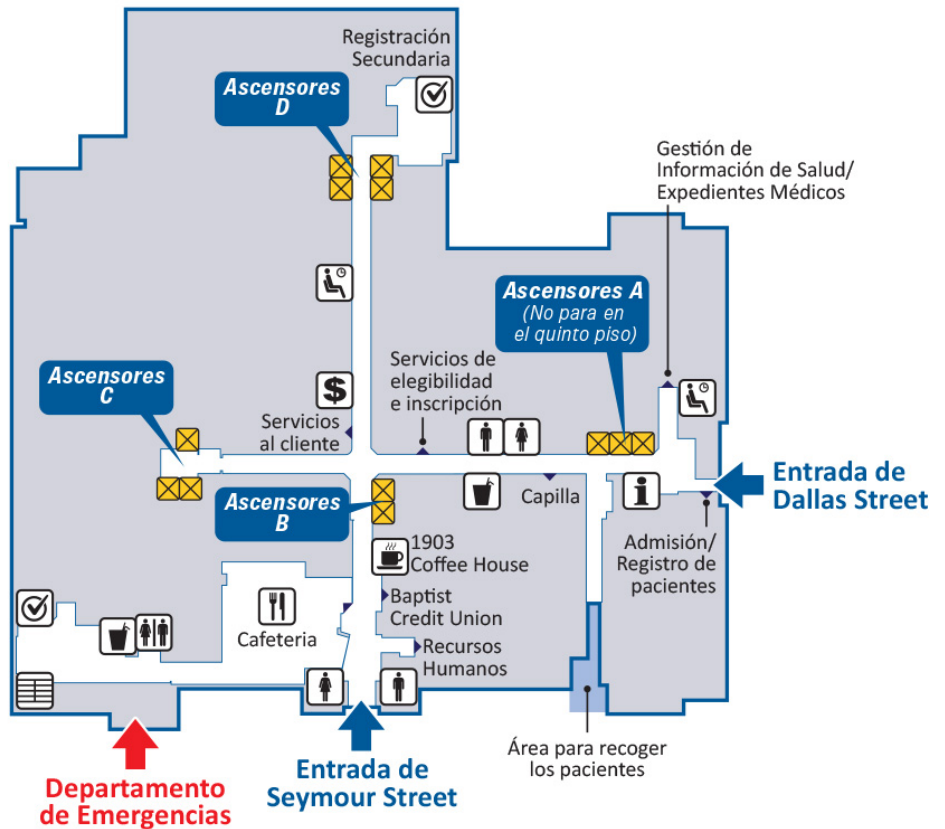

Segundo piso

Segundo piso

Leyenda

- Ascensor(es)
- Admisión/ Registro de pacientes
- Area de espera
- Baños

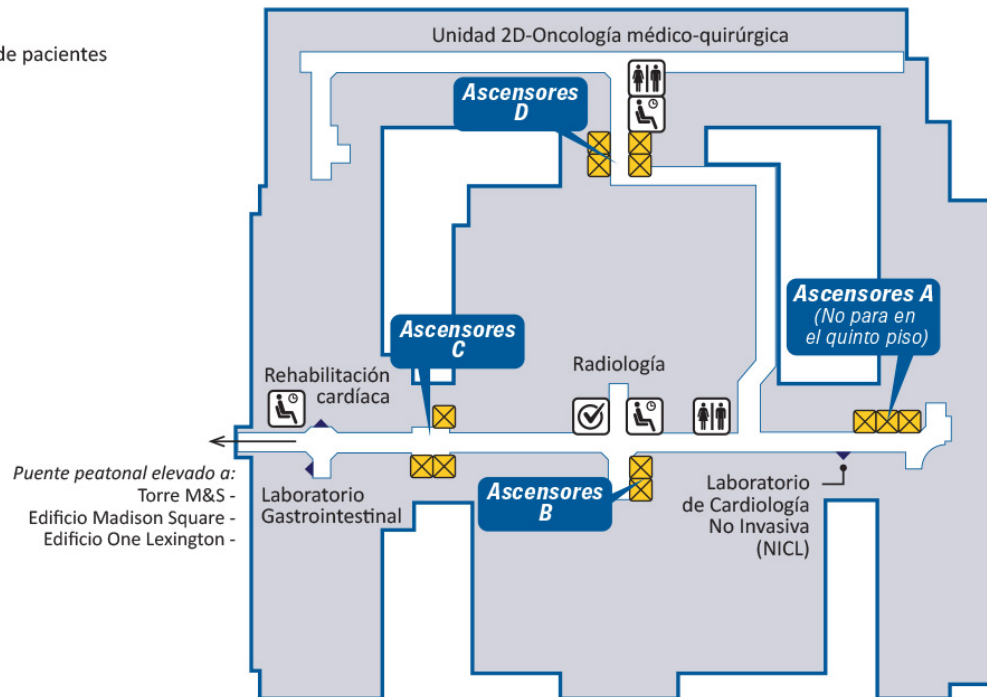

Tercer piso

Tercer piso

Leyenda

- ✘ Ascensor(es)
- ♿ Área de espera
- ♿ Baños
- 🗑 Máquina expendedora

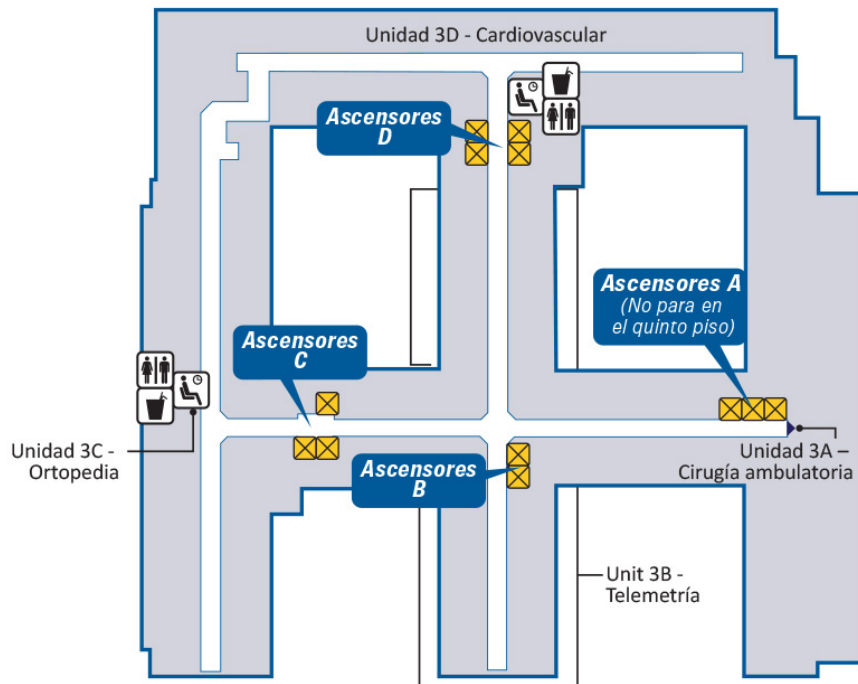

Cuarto piso

Cuarto piso

Leyenda

- Ascensor(es)
- Area de espera
- Baños

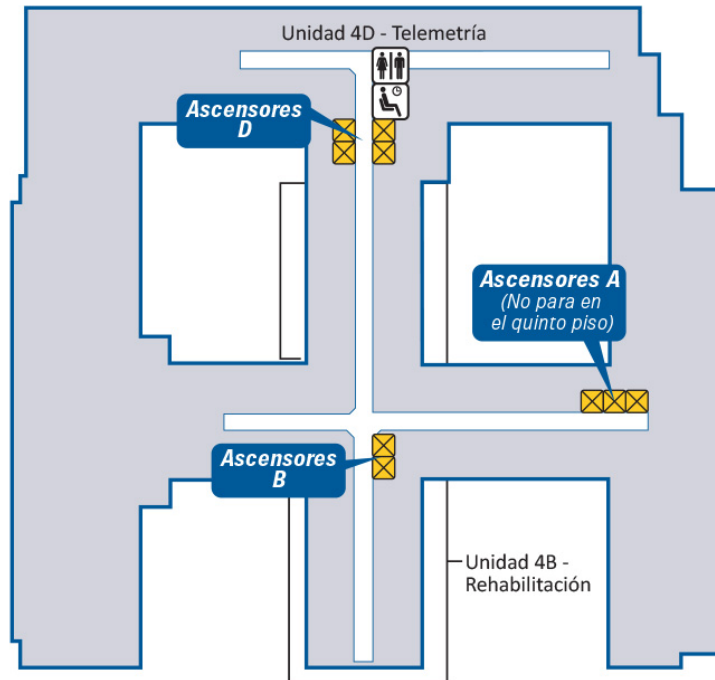

Quinto piso

Quinto piso

Leyenda

- Ascensor(es)
- Area de espera
- Baños

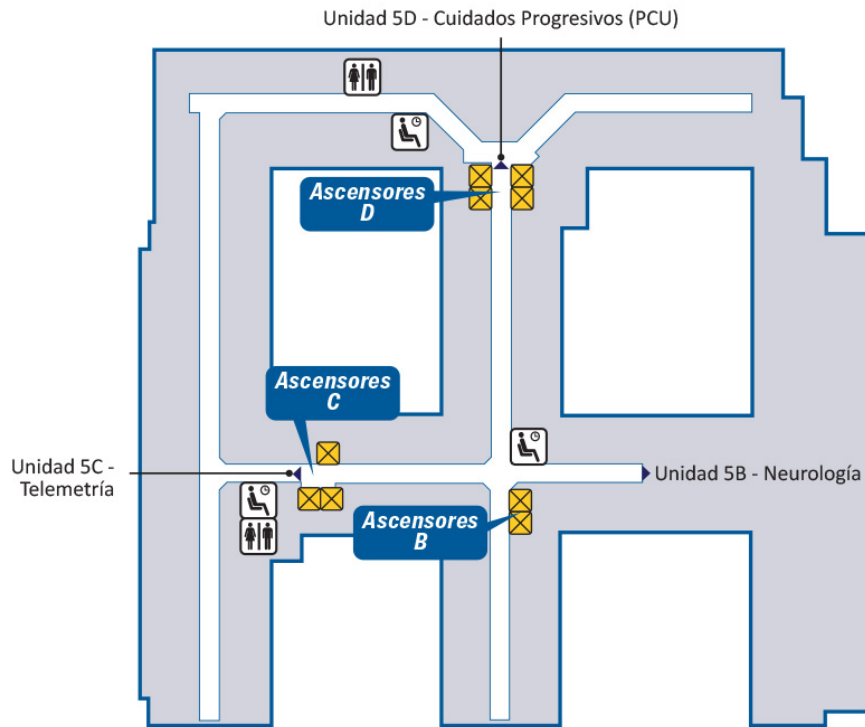

Sexto piso

Sexto piso

Leyenda

- ✘ Ascensor(es)
- ♿ Area de espera
- ♿ Baños
- 🗑 Máquina expendedora

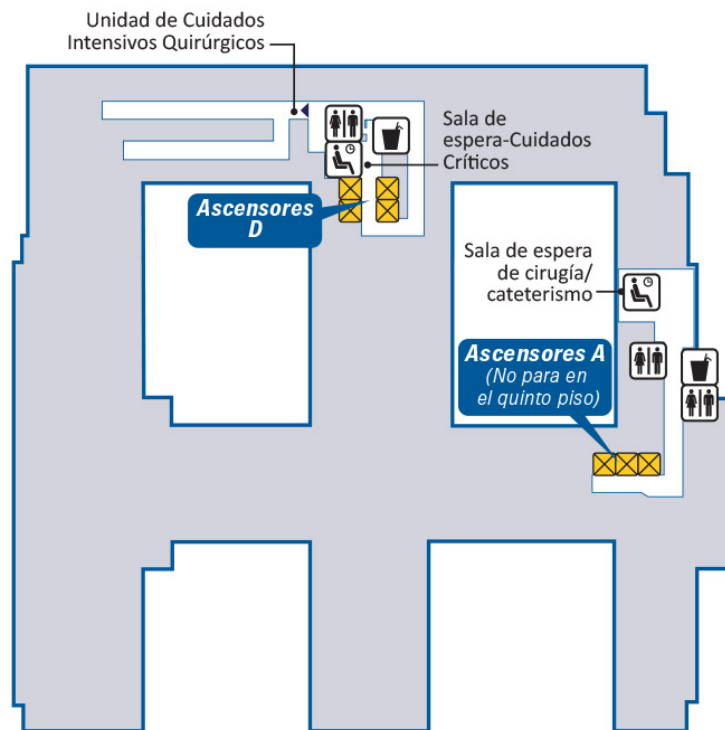

Séptimo piso

Séptimo piso

Leyenda



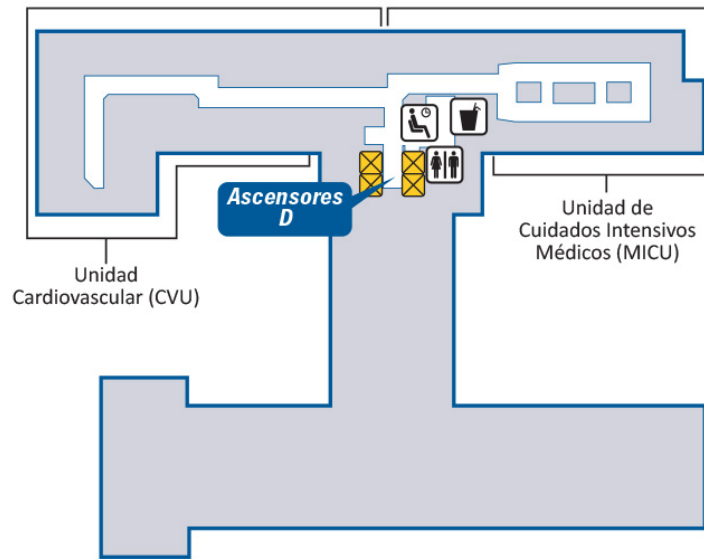

- ✘ Ascensor(es)
- ♿ Area de espera
- ♿ Baños
- 🗑 Máquina expendedora



Octavo piso

Octavo piso

Leyenda

-  Ascensor(es)
-  Area de espera
-  Baños
-  Máquina expendedora

